

Calendar „Pentagon“

The model was originally designed by Tomoko Fuse, Japan and designed as a calendar by Sara Giarrusso and Ramin Razani, Italy. Pictures and the diagrams (Paola Scaburri) are published at

<http://www.origami-cdo.it/modelli/pdf/>



Centro Diffusione Origami

This calendar-model was optimised by Matthias Eichel, Kassel and Stefan Delecat, Göttingen, provided with optimised folding instructions too and published as calendar in German and English language first for 2007 and again **for 2019** for the members and all friends of Origami Deutschland.

Happy folding

Stefan Delecat and Matthias Eichel

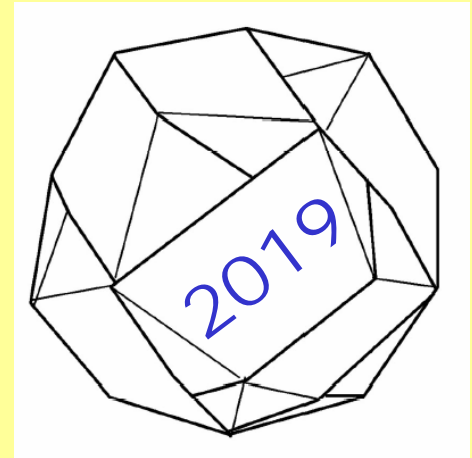

January

February

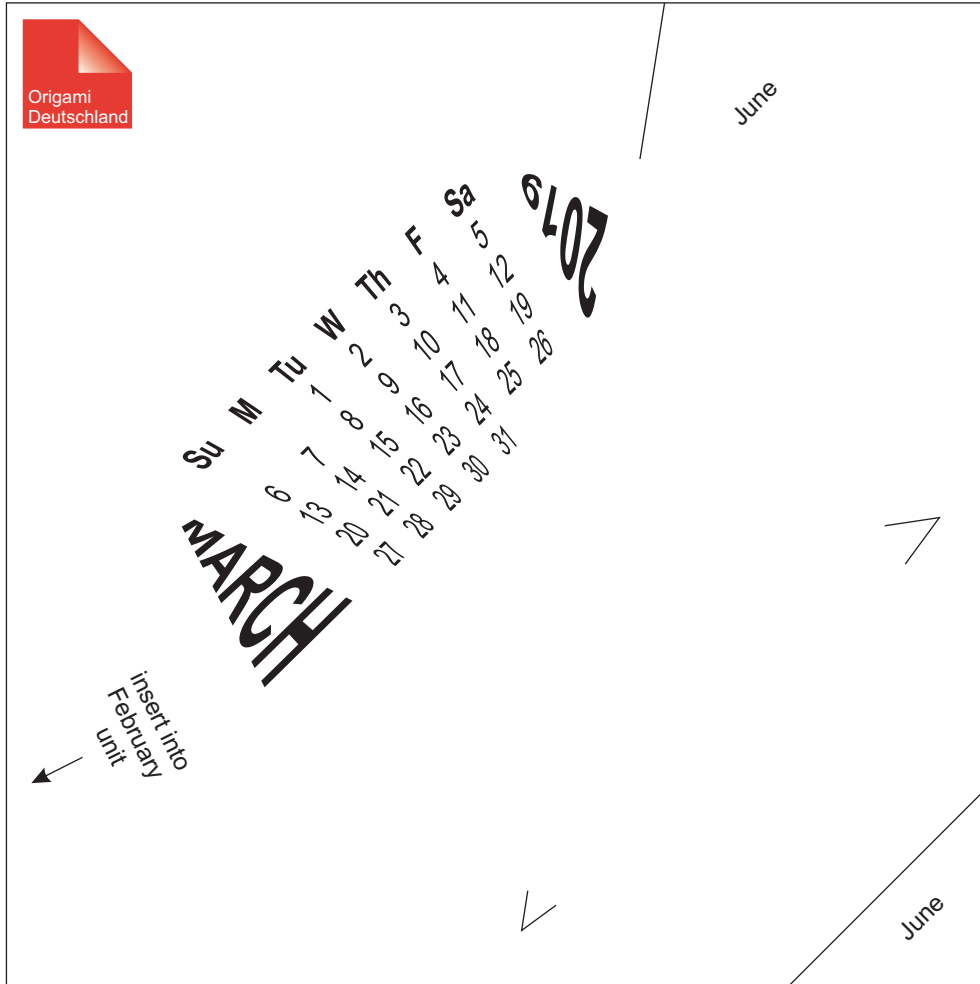

March

April



Origami
Deutschland

May

2019

Su	M	Tu	W	Th	F	Sa
					1	2
3	4	5	6	7	8	9
10	11	12	13	14	15	16
17	18	19	20	21	22	23
24	25	26	27	28	29	30
31						

FEBRUARY

insert into
January
unit

May



Origami
Deutschland

March

2019

Su	M	Tu	W	Th	F	Sa
						6
7	8	9	10	11	12	13
14	15	16	17	18	19	20
21	22	23	24	25	26	27
28	29	30				

JUNE

insert into
August
unit

March

May

June



April

2019

Su	M	Tu	W	Th	F	Sa
	5	6	7	8	9	10
12	13	14	15	16	17	18
19	20	21	22	23	24	25
26	27	28	29	30	31	

JULY

insert into December unit

April



November

2019

Su	M	Tu	W	Th	F	Sa
	2	3	4	5	6	7
9	10	11	12	13	14	15
16	17	18	19	20	21	22
23	24	25	26	27	28	29
30						

AUGUST

insert into April unit

November

July



September

DECEMBER

Su	M	Tu	W	Th	F	Sa
7	8	9	10	11	12	13
14	15	16	17	18	19	20
21	22	23	24	25	26	27
28	29	30	31			

2019

insert into
May
unit

September

August



July

APRIL

Su	M	Tu	W	Th	F	Sa
4	5	6	7	8	9	10
11	12	13	14	15	16	17
18	19	20	21	22	23	24
25	26	27	28	29	30	31

2019

insert into
June
unit

July

September

October



August

2019

Su	M	Tu	W	Th	F	Sa
1	2	3	4	5	6	7
8	9	10	11	12	13	14
15	16	17	18	19	20	21
22	23	24	25	26	27	28
29	30					

NOVEMBER

insert into October unit

August



December

2019

Su	M	Tu	W	Th	F	Sa
6	7	8	9	10	11	12
13	14	15	16	17	18	19
20	21	22	23	24	25	26
27	28	29	30	31		

SEPTEMBER

insert into November unit

December

November



Origami
Deutschland

January

2019

Su	M	Tu	W	Th	F	Sa
	3	4	5	6	7	8
10	11	12	13	14	15	16
17	18	19	20	21	22	23
24	25	26	27	28	29	30

OCTOBER

insert into
September
unit

January

December



Origami
Deutschland

February

2019

Su	M	Tu	W	Th	F	Sa
1	2	3	4	5	6	7
8	9	10	11	12	13	14
15	16	17	18	19	20	21
22	23	24	25	26	27	28
29	30	31				

MAY

insert into
July
unit

February

Folding Diagram page 1

1

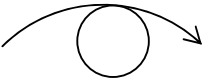
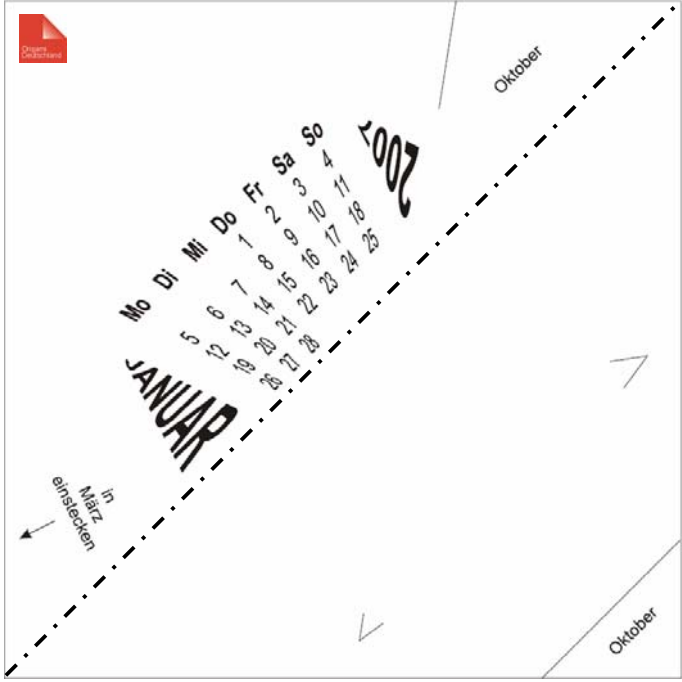

2

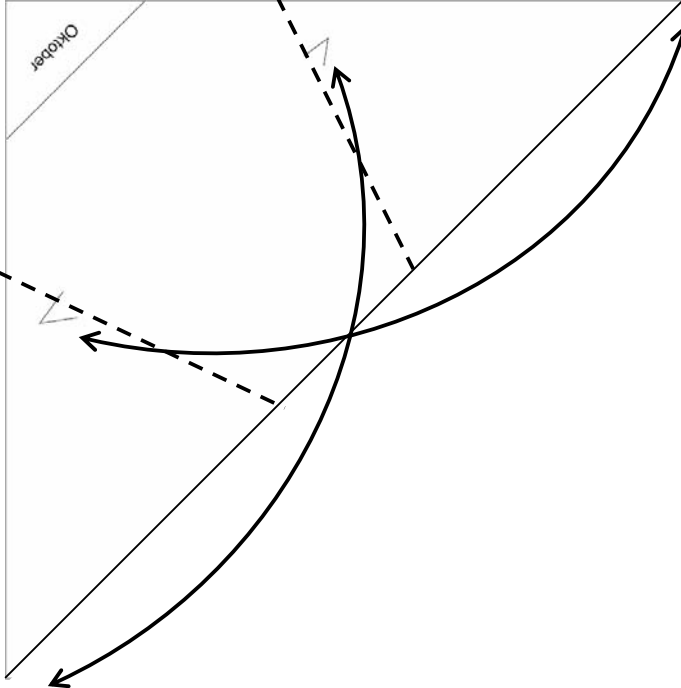

3a

Both layers

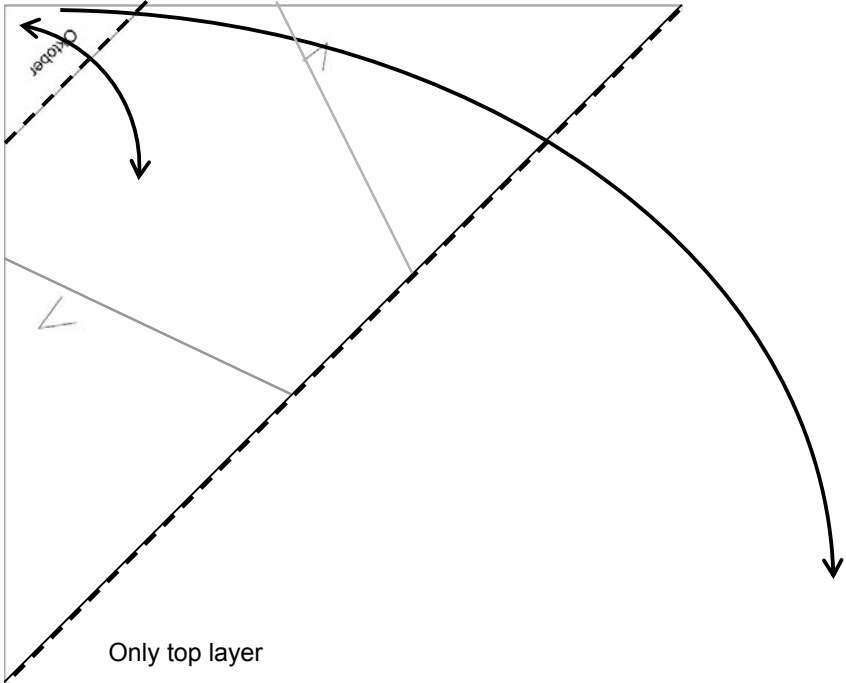

3b

Only top layer

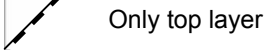

4a

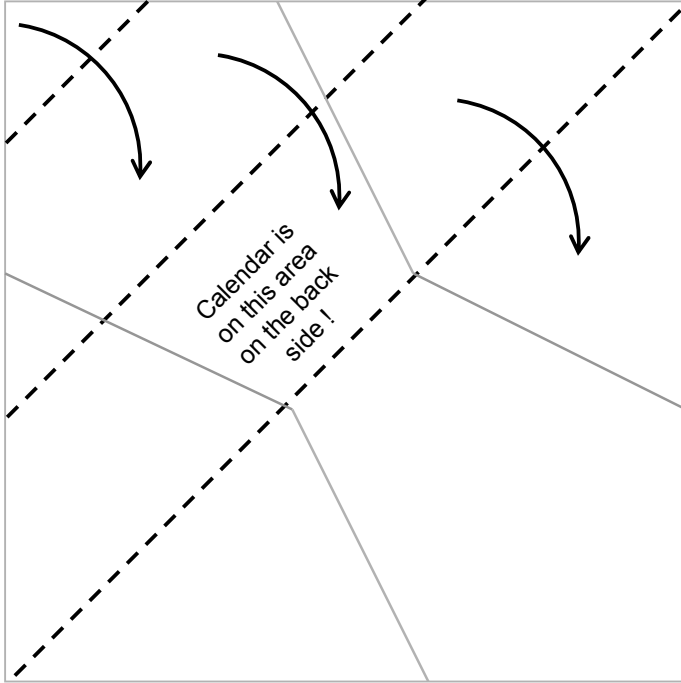

4b

4c

5

Mountain fold only bottom layer

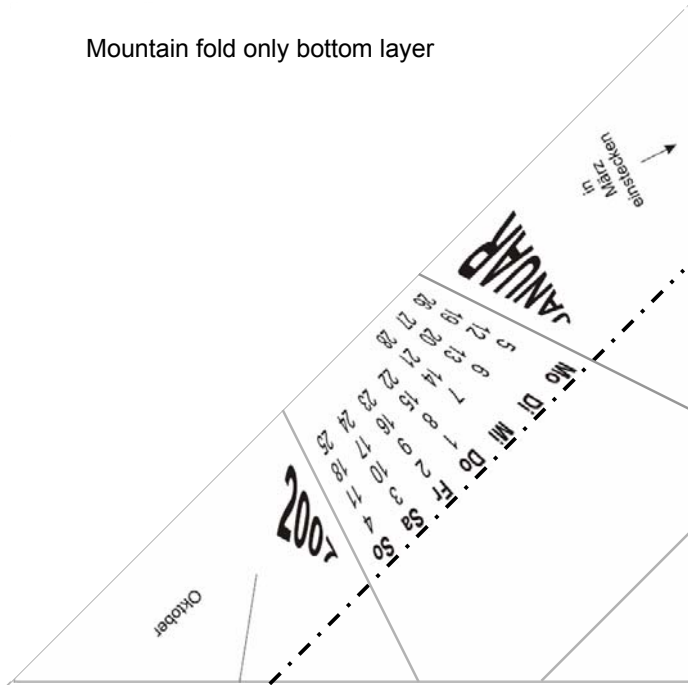

6

Mountain fold the existing crease through all layers

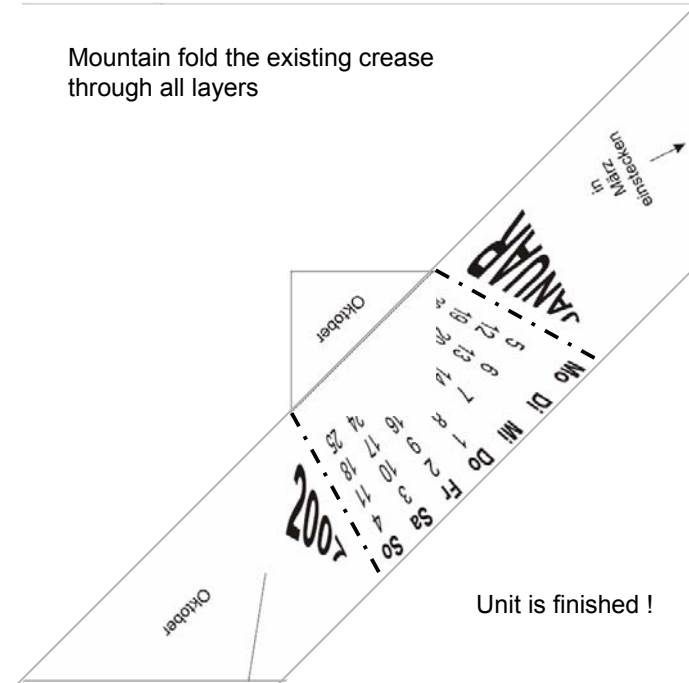

Folding Diagram page 2

7a

Put the flap of unit 2 into the pocket of unit 1

Note: The month written on the flap of unit 2 refers to the unit with the imprinted name of this month with expanded font (unit 1)

7b

Put the outer edge of unit 2 to the marking line of unit 1. Fold the supernatant little flaps over and put them into the pockets.

7c

Put the outer edge of unit 1 to the marking line of unit 2. Fold the supernatant little flaps over and put them into the pockets.

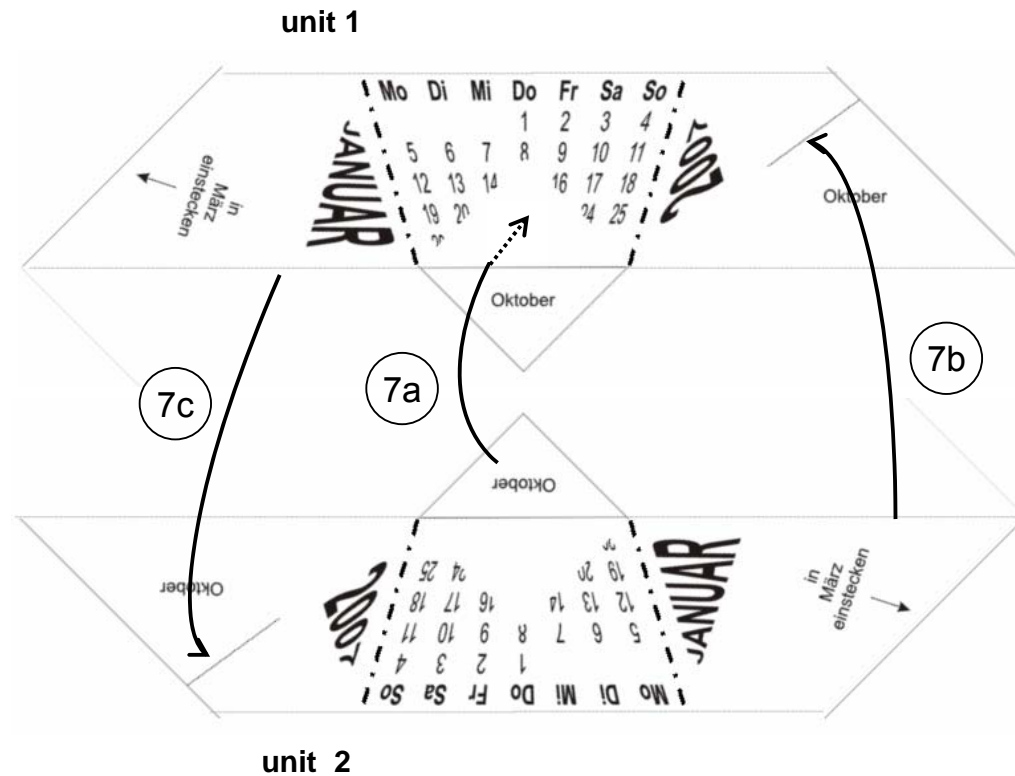

Assembly

8

Make 6 of these „duo-units“

9

Put the „duo-units“ together to finish the Pentagon

Note: The advice „put into pocket of month“ means, that the flap of the unit with this advice is put into the pocket of the unit with imprinted name of the month with expanded font

Suggestion for multi-coloured calendars

Paper with imprinted name of the month ...	Coloured calendar with 1 colour	Coloured calendar with 3 colours	Coloured calendar with 6 colours	Coloured calendar with 12 colours
March	Colour 1	Colour 1	Colour 1	Colour 1
June	Colour 1	Colour 1	Colour 6	Colour 2
September	Colour 1	Colour 1	Colour 6	Colour 3
December	Colour 1	Colour 1	Colour 1	Colour 4
November	Colour 1	Colour 2	Colour 2	Colour 5
August	Colour 1	Colour 2	Colour 5	Colour 6
May	Colour 1	Colour 2	Colour 5	Colour 7
February	Colour 1	Colour 2	Colour 2	Colour 8
October	Colour 1	Colour 3	Colour 3	Colour 9
January	Colour 1	Colour 3	Colour 4	Colour 10
April	Colour 1	Colour 3	Colour 4	Colour 11
July	Colour 1	Colour 3	Colour 3	Colour 12

Folding Diagram for a calendar holder „column“ (a variation of the „chopstick holder “ by Didier Boursin)

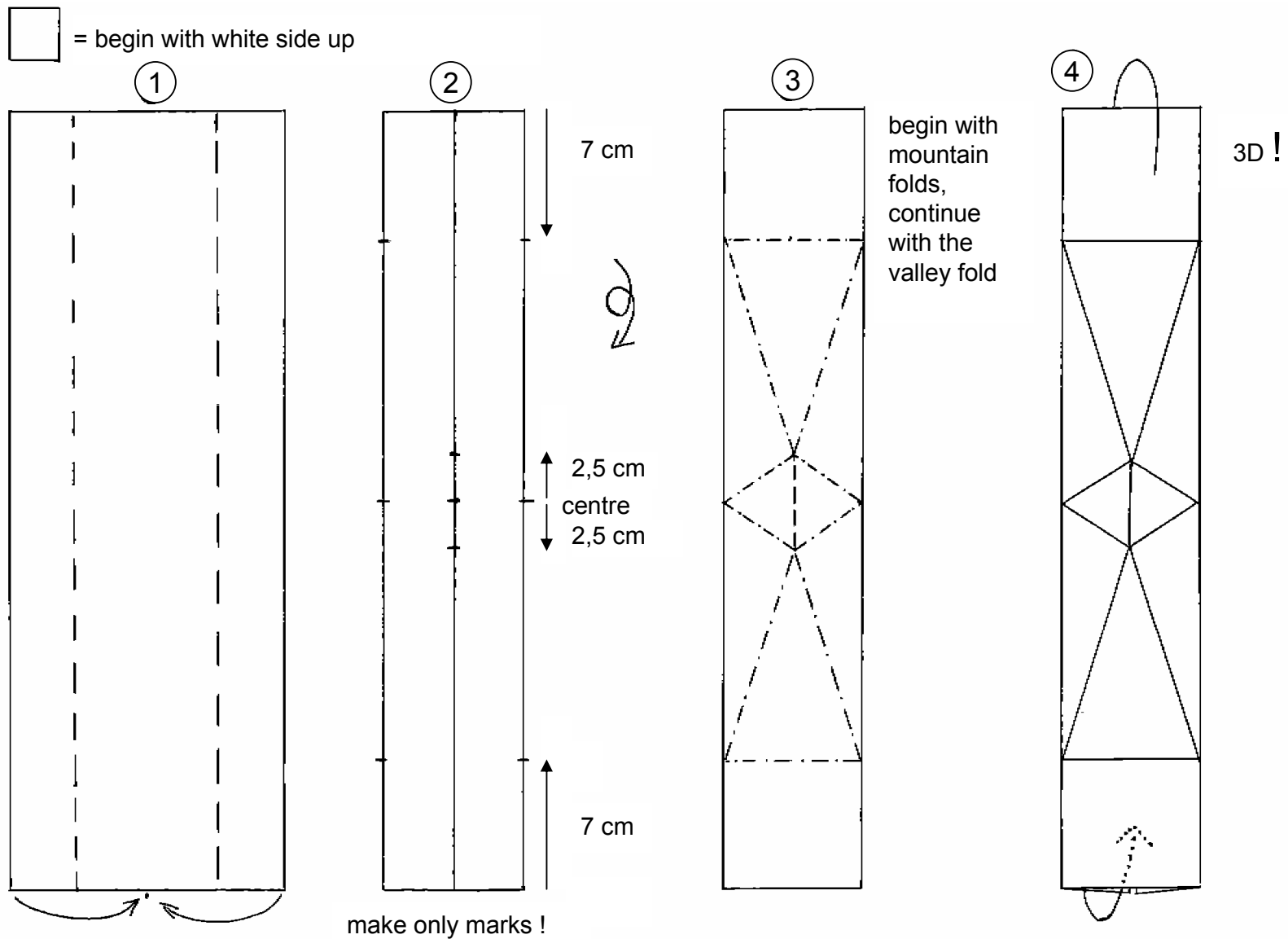

Suggestion for paper format: $\frac{1}{2}$ of DIN A 3 = 42 cm x 14,8 cm, best result with 160g-paper,
Suggestion for colour: black paper (coloured on both sides)

Background-Information: geometrical basis

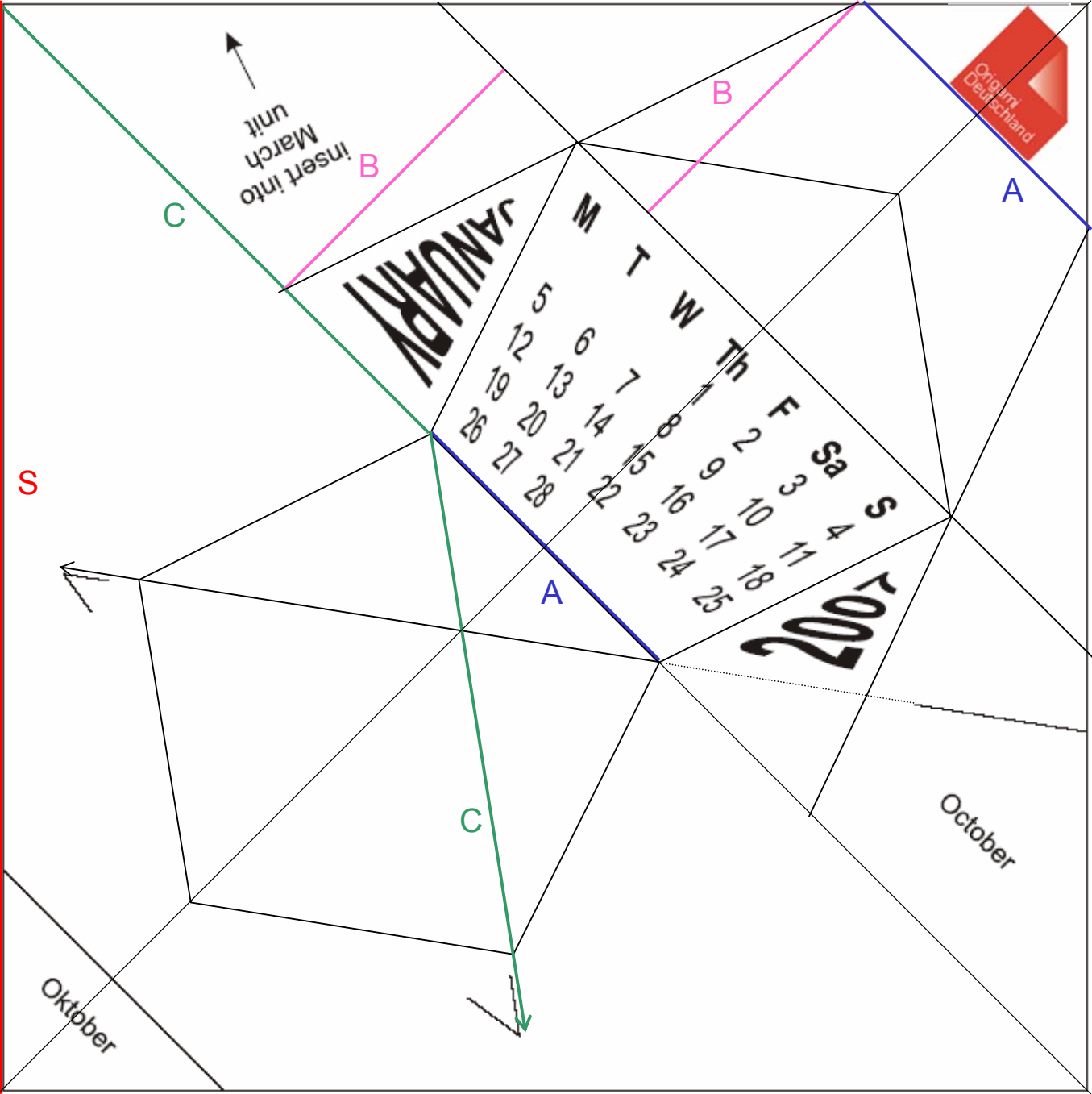

For a given regular pentagon with side length „A“ the size of the square is the following:

The "height" of the Pentagon from the bottom line up to the broadest place „B“ (1st parallel line to the diagonal line of the square) is duplicated (2nd parallel line to the diagonal line).

The length of this diagonal line is „A“. On top we put another right-angled triangle. This entire construction make up 1/2 of the length of the diagonal line of the final square.

The side length „S“ of the final square results as:

$$S = 2 \times \sqrt{\frac{(2B + 0,5A)^2}{2}}$$

The position of the arrows is:

You take an arrow with length: From an edge of the square to the beginning of the bottom edge of the pentagon „C“ and twist it that it starts at the bottom edge of the pentagon and points through the meeting point of the 1st parallel line with the pentagon. The end of the arrow is the "magic" point we looked for.