

# Calendar „Pentagon“

The model was originally designed by Tomoko Fuse, Japan and designed as a calendar by Sara Giarrusso and Ramin Razani, Italy. Pictures and the diagrams (Paola Scaburri) are published at

<http://www.origami-cdo.it/modelli/pdf/>



Centro Diffusione Origami

This calendar-model was optimised by Matthias Eichel, Kassel and Stefan Delecat, Göttingen, provided with optimised folding instructions too and published as calendar in German and English language first for 2007 and again **for 2020** for the members and all friends of Origami Deutschland.

Happy folding

*Stefan Delecat and Matthias Eichel*

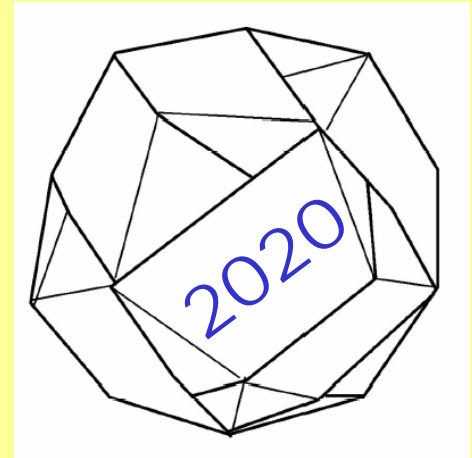

# January

# February



Origami  
Deutschland

June

2020

Su	M	Tu	W	Th	F	Sa
5	6	7	8	9	10	11
12	13	14	15	16	17	18
19	20	21	22	23	24	25
26	27	28	29	30	31	

**MARCH**

insert into  
February  
unit

June



Origami  
Deutschland

October

2020

Su	M	Tu	W	Th	F	Sa
2	3	4	5	6	7	8
9	10	11	12	13	14	15
16	17	18	19	20	21	22
23	24	25	26	27	28	29

**JANUARY**

insert into  
March  
unit

Oktober

# March



Origami  
Deutschland

May

2020

Su	M	Tu	W	Th	F	Sa
1	2	3	4	5	6	7
8	9	10	11	12	13	14
15	16	17	18	19	20	21
22	23	24	25	26	27	28
29	30	31				

FEBRUARY

insert into  
January  
unit

May

# April



Origami  
Deutschland

March

2020

Su	M	Tu	W	Th	F	Sa
5	6	7	8	9	10	11
12	13	14	15	16	17	18
19	20	21	22	23	24	25
26	27	28	29	30		

JUNE

insert into  
August  
unit

March

# May

# June



April

2020

Su	M	Tu	W	Th	F	Sa
					1	2
3	4	5	6	7	8	9
10	11	12	13	14	15	16
17	18	19	20	21	22	23
24	25	26	27	28	29	30
31						

JULY

insert into December Unit

April



November

2020

Su	M	Tu	W	Th	F	Sa
						6
7	8	9	10	11	12	13
14	15	16	17	18	19	20
21	22	23	24	25	26	27
28	29	30				

AUGUST

insert into April unit

November

# July

# August



Origami  
Deutschland

September

DECEMBER

Su	M	Tu	W	Th	F	Sa
						2020
5	6	7	8	9	10	11
12	13	14	15	16	17	18
19	20	21	22	23	24	25
26	27	28	29	30	31	

insert into  
May  
unit

September



Origami  
Deutschland

July

APRIL

Su	M	Tu	W	Th	F	Sa
						2020
2	3	4	5	6	7	8
9	10	11	12	13	14	15
16	17	18	19	20	21	22
23	24	25	26	27	28	29
30	31					

insert into  
June  
unit

July

# September

# October



August

2020

Su	M	Tu	W	Th	F	Sa
	7	1	2	3	4	5
6	13	14	8	9	10	11
20	21	15	16	17	18	12
27	28	22	23	24	25	19
		29	30			26

NOVEMBER

insert into  
October  
unit

August



December

2020

Su	M	Tu	W	Th	F	Sa
	5	6	7	1	2	3
4	11	12	13	14	15	16
18	19	20	21	22	23	17
25	26	27	28	29	30	24
						31

SEPTEMBER

insert into  
November  
unit

December

# November



Origami  
Deutschland

January

2020

Su	M	Tu	W	Th	F	Sa
1	2	3	4	5	6	7
8	9	10	11	12	13	14
15	16	17	18	19	20	21
22	23	24	25	26	27	28
29	30					

OCTOBER

insert into  
September  
unit

January

# December



Origami  
Deutschland

February

2020

Su	M	Tu	W	Th	F	Sa
6	7	8	9	10	11	12
13	14	15	16	17	18	19
20	21	22	23	24	25	26
27	28	29	30	31		

MAY

insert into  
July  
unit

February

# Folding Diagram page 1

1

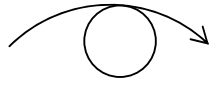
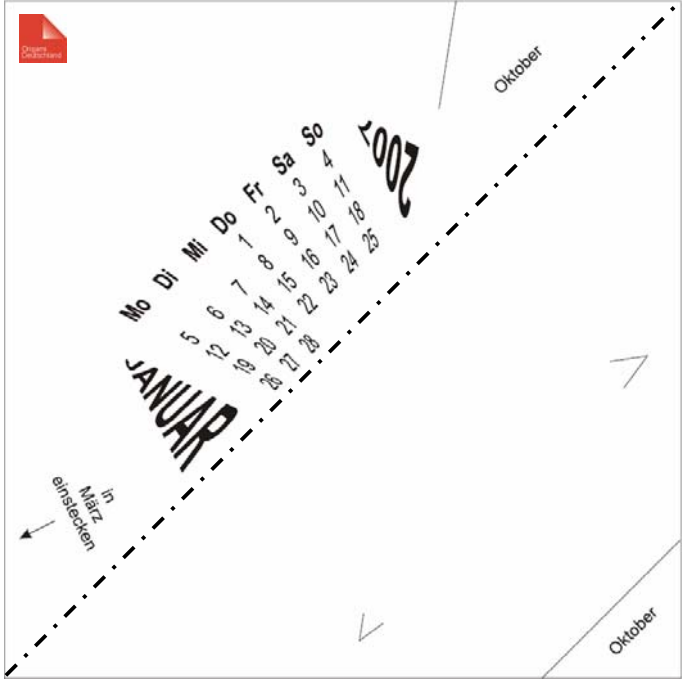

2

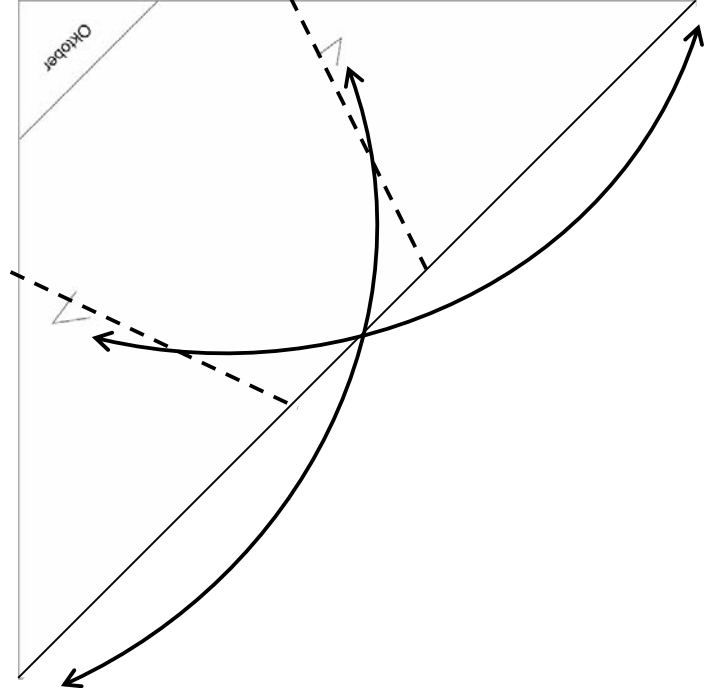

3a

Both layers

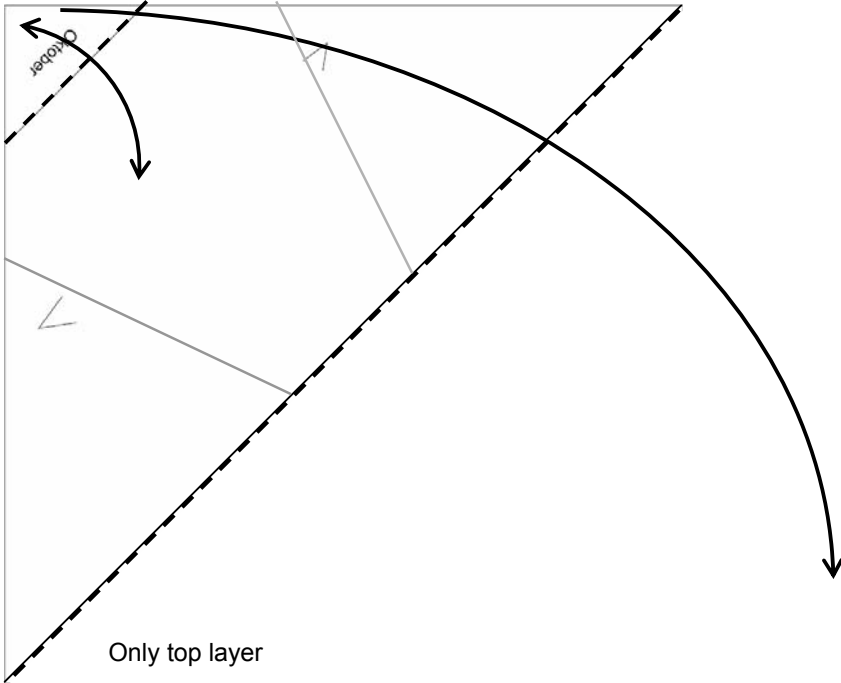

3b

Only top layer

4a

4b

4c

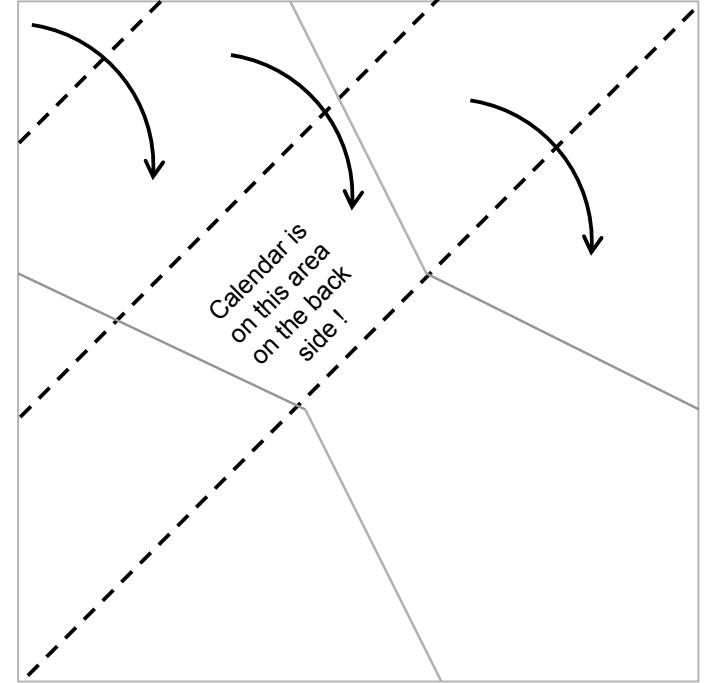



5

Mountain fold only bottom layer

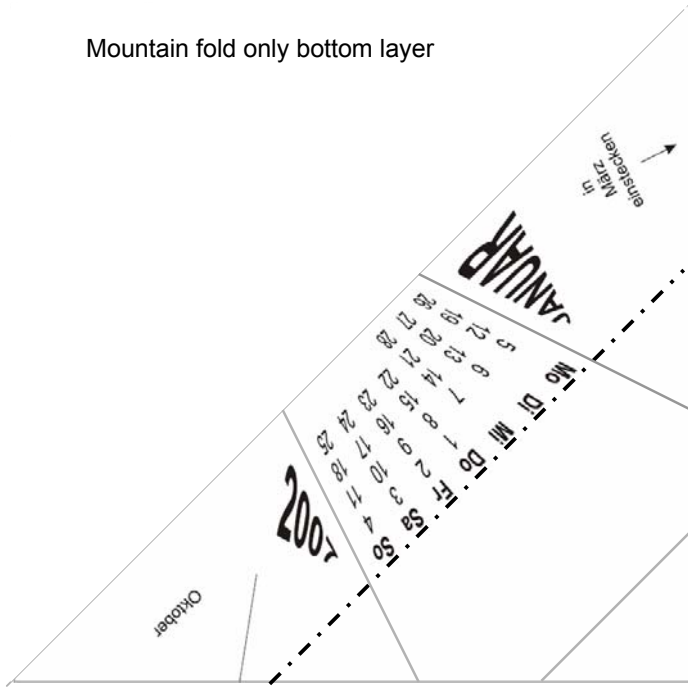

6

Mountain fold the existing crease through all layers

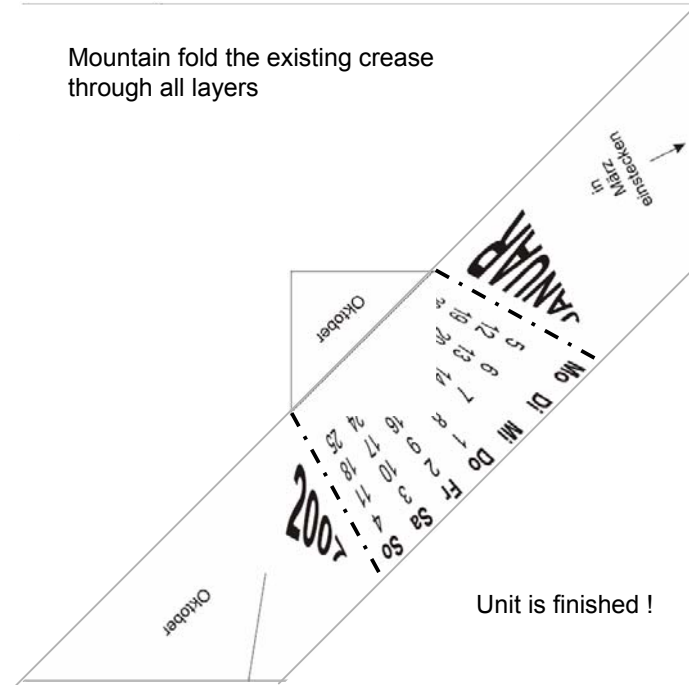

Folding Diagram page 2

7a

Put the flap of unit 2 into the pocket of unit 1

**Note:** The month written on the flap of unit 2 refers to the unit with the imprinted name of this month with expanded font (unit 1)

7b

Put the outer edge of unit 2 to the marking line of unit 1. Fold the supernatant little flaps over and put them into the pockets.

7c

Put the outer edge of unit 1 to the marking line of unit 2. Fold the supernatant little flaps over and put them into the pockets.

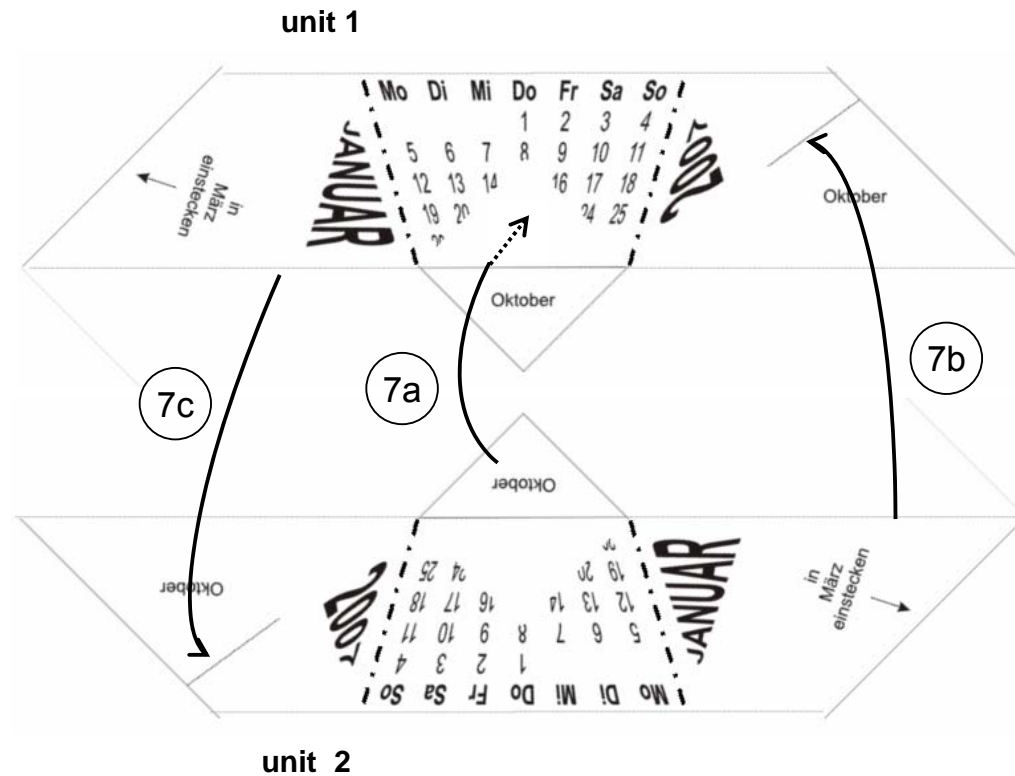

Assembly

8

Make 6 of these „duo-units“

9

Put the „duo-units“ together to finish the Pentagon

**Note:** The advice „put into pocket of month“ means, that the flap of the unit with this advice is put into the pocket of the unit with imprinted name of the month with expanded font

## Suggestion for multi-coloured calendars

Paper with imprinted name of the month ...	Coloured calendar with 1 colour	Coloured calendar with 3 colours	Coloured calendar with 6 colours	Coloured calendar with 12 colours
March	Colour 1	Colour 1	Colour 1	Colour 1
June	Colour 1	Colour 1	Colour 6	Colour 2
September	Colour 1	Colour 1	Colour 6	Colour 3
December	Colour 1	Colour 1	Colour 1	Colour 4
November	Colour 1	Colour 2	Colour 2	Colour 5
August	Colour 1	Colour 2	Colour 5	Colour 6
May	Colour 1	Colour 2	Colour 5	Colour 7
February	Colour 1	Colour 2	Colour 2	Colour 8
October	Colour 1	Colour 3	Colour 3	Colour 9
January	Colour 1	Colour 3	Colour 4	Colour 10
April	Colour 1	Colour 3	Colour 4	Colour 11
July	Colour 1	Colour 3	Colour 3	Colour 12

# Folding Diagram for a calendar holder „column“ (a variation of the „chopstick holder “ by Didier Boursin)

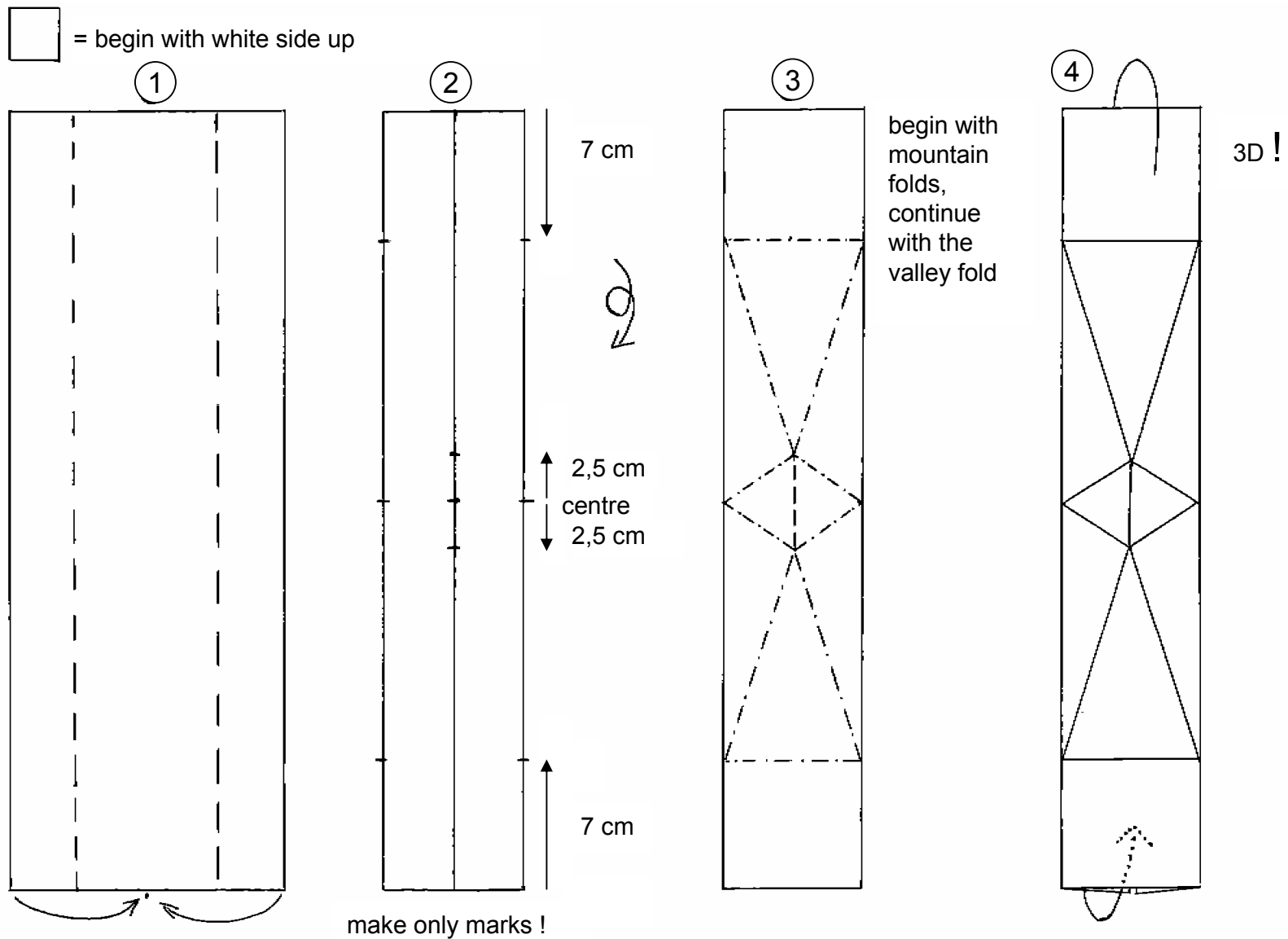

Suggestion for paper format:  $\frac{1}{2}$  of DIN A 3 = 42 cm x 14,8 cm, best result with 160g-paper,  
Suggestion for colour: black paper (coloured on both sides)

# Background-Information: geometrical basis

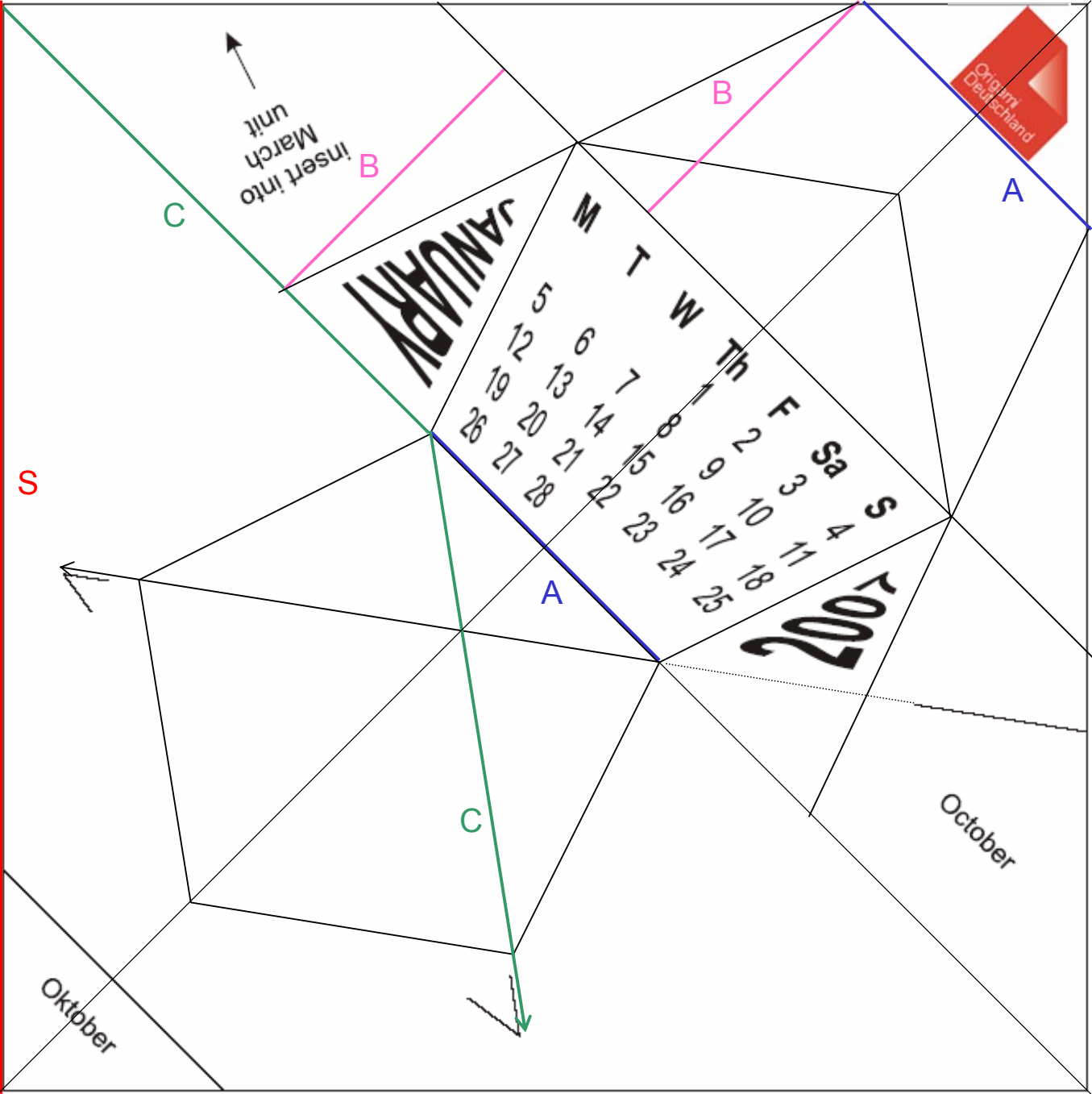

For a given regular pentagon with side length „A“ the size of the square is the following:

The "height" of the Pentagon from the bottom line up to the broadest place „B“ (1<sup>st</sup> parallel line to the diagonal line of the square) is duplicated (2<sup>nd</sup> parallel line to the diagonal line).

The length of this diagonal line is „A“. On top we put another right-angled triangle. This entire construction make up 1/2 of the length of the diagonal line of the final square.

The side length „S“ of the final square results as:

$$S = 2 \times \sqrt{\frac{(2B + 0,5A)^2}{2}}$$

The position of the arrows is:

You take an arrow with length: From an edge of the square to the beginning of the bottom edge of the pentagon „C“ and twist it that it starts at the bottom edge of the pentagon and points through the meeting point of the 1<sup>st</sup> parallel line with the pentagon. The end of the arrow is the "magic" point we looked for.